

# Robotalk

Envelope filter

xotic effects usa

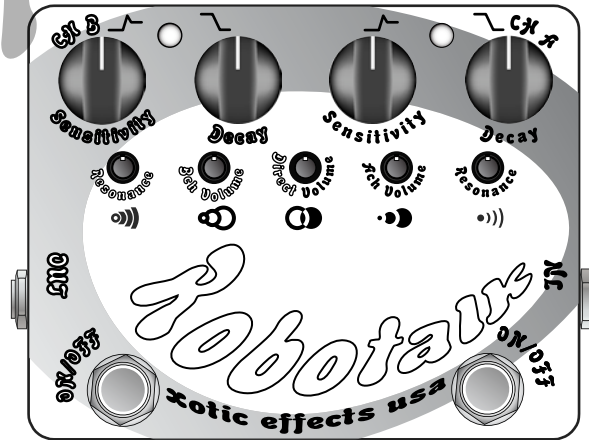

Congratulations on your purchase of the NEW Xotic Robotalk2! The Robotalk 2 sports two individual envelope filter channels. Each channel is independently voiced and can be preset for different playing style, slow acoustic-like attack, percussive, high speed open-close and many more. Blend each channel together for additional tones or use the internal dip switch to customize your sounds appropriately. There's a switchable input pad for accommodating both active and passive signals.

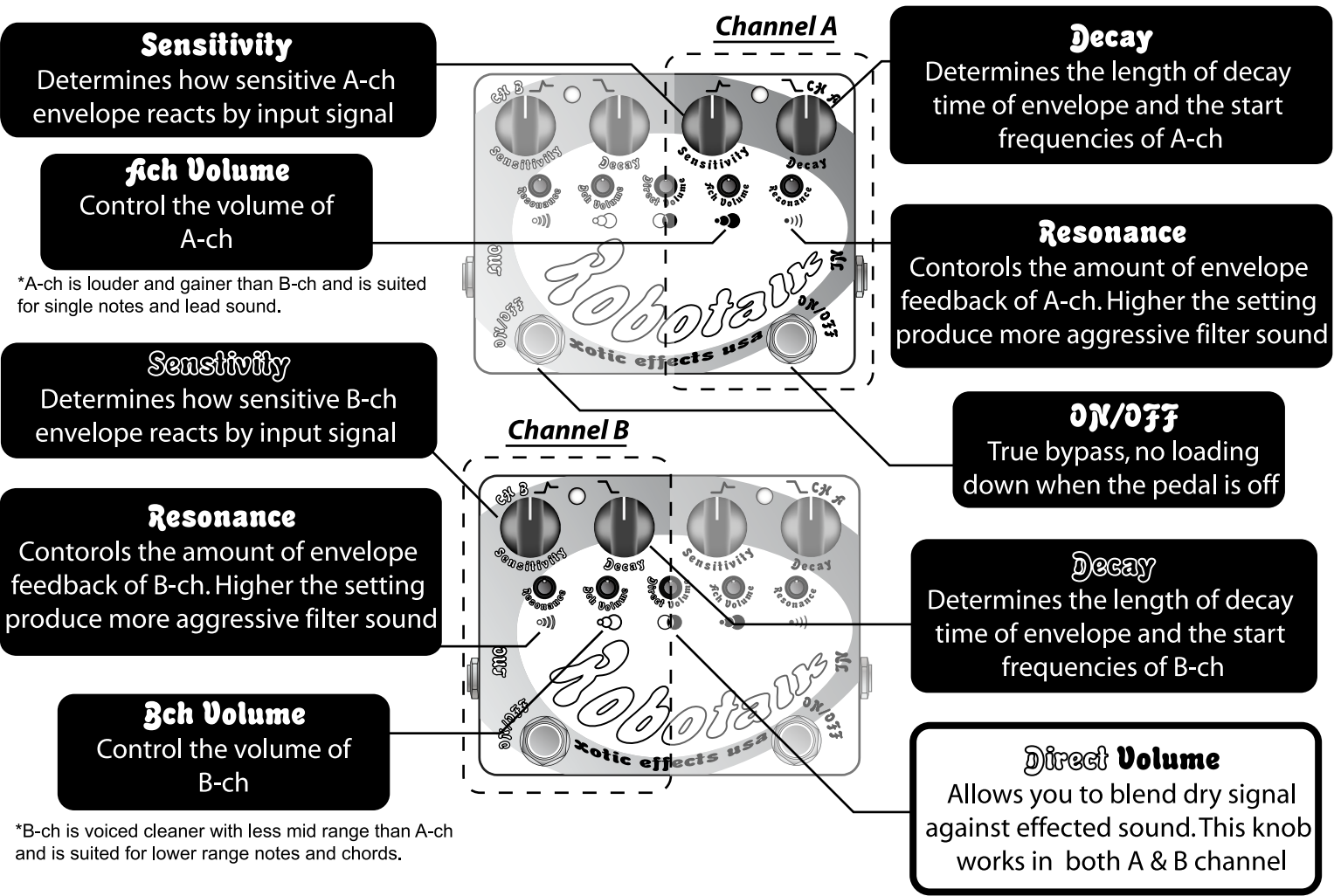

## Internal Dip Switch Setting:

To access the dip switch, remove the bottom plate by unscrewing the 4 screws.

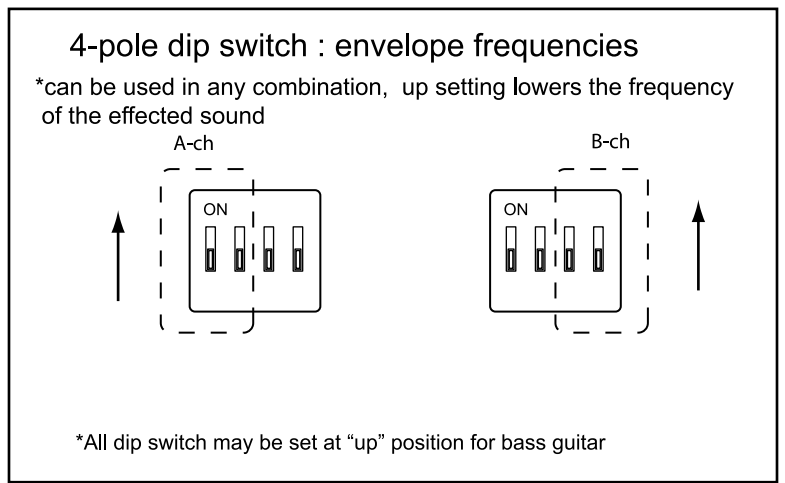

## 2-pole dip switch : Input pad settings

\*adjust the settings for minimum distortion

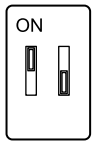

Default :  
For low power P.U.  
single coil &  
vintage type PAF

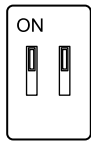

For medium  
power P.U.  
over 16kdc  
coil resistance

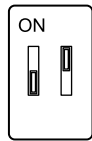

For active  
P.U. and preamp  
equipped guitar &  
bass guitar

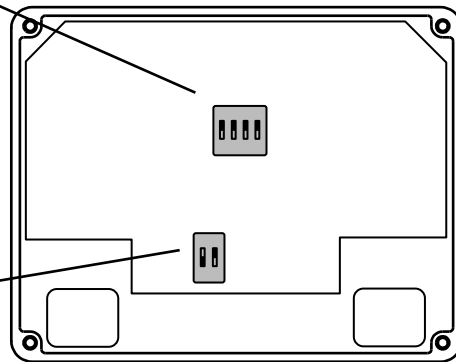

inside view

## Sample Sound Settings:

### Dual Sound Filter



**Low peak filter: B channel only**  
**High peak filter: A channel only**

### Envelope Phaser



**A+B channel**

Input impedance (selectable): 1M or 10K ohm

Output impedance: 1K ohm

Max current draw: 20mA

Dimensions: W4.62" D3.65" H2"

Weight: 0.9 lbs

9V Battery: Alkaline recommended, 20-hours with nominal use

Optional external power supply: 9 volt DC (regulated recommended)

2.1mm x 5.5mm standard barrel with negative tip (center)

such as Boss PSA, Ibanez AC109, Dunlop Power brick, Voodoo Labs

Power-all, 1-spot, etc